

TEMPERATURE CONTROLLER

C ← BUS

DTF 31.. C1 Eng.



- **Configurable temperature control:**
 - Three-wire modulating with PI control mode
 - On-Off in one or two stages
 - On-Off proportional in one stage
- **Communication system :**
 - C-Bus for Telemangement
- **Power supply 230 V~ or 24 V~; DIN rail mounting.**

1. APPLICATION

DTF 31.. controller is designed for hot or cold temperature control in the following applications:

- DHW production;
- heating swimming pool water;
- underfloor heating panels or fan coils;
- heating horticultural beds;
- convectors

By means of the C-Bus connection DTF 31.. can be included in a Telemangement system.

VERSIONS :

- DTF 318** : Power supply 230 V~
- DTF 314** : Power supply 24 V~

2. FUNCTIONS

The principal functions of DTF 31.. are :

- Temperature control with room, air duct or immersion NTC 10 kΩ detectors:
 - at a constant value : detector B1 (range 0...40 °C);
 - or
 - detector B2 (range 0...99 °C);
 - or
 - detector B1 (range 0...40 °C) and flow detector B2 (range 0...99 °C)
- Control output:
 - three-wire modulating;
 - On-Off in one or two stages;
 - On-Off proportional in one stage.
- Adjustment of desired value by means of remote set-point adjuster.

3. DETECTORS & REMOTE CONTROLS

No.	Description	Type	Sensing element	Code	Data sheet
1 or 2	Temperature detector immersion type or room or air duct or cable type	SIH 010 SAB 010 STA 010 SAF 010	NTC 10 kΩ NTC 10 kΩ NTC 10 kΩ NTC 10 kΩ	B1-B2 B1 B1-B2 B1-B2	N 140 N 111 N 150 N 145
1	Optional : Set-point adjuster	CDB 100	–	Rt°	–

4. TECHNICAL DATA (factory settings in bold type)**• Electrical**

Power supply:	
DTF 318	230 V~ ± 10%
DTF 314	24 V~ ± 10%
Frequency	50...60 Hz
Consumption	3 VA
Protection	IP40
Radio disturbance	VDE0875/0871
Vibration test	with 2g (DIN 40 046)
Voltage-free output contacts:	
Maximum switched voltage	250 V~
Maximum switched current	5 (1) A
Construction standards	Italian Electrotech. Committee CEI
Software	Class A

• Mechanical

Case	DIN 3E module
Mounting	on DIN 35 rail
Materials	
Base	NYLON
Cover	ABS
Permitted ambient temperature::	
Operating	0...45 °C
Storage	- 25...+ 60 °C
Permitted ambient humidity	Class F DIN 40040
Weight	0.27 kg

• Setting range (..) = cooling

Desired temperature	
With detector B1 or B1+B2	0... 20(25) ...40 °C
With detector B2 only	0... 20(25) ...99 °C
Desired temperature adjustment:	
With detector B1 or B1+B2	± 5 °C
With detector B2 only	± 10 °C
Min. flow temperature limit	0... 18(10) ...99 °C
Max. flow temperature limit	0... 50(30) ...99 °C
Control output:	- three-wire modulating - On-Off in one or two stages - On-Off proportional in one stage
Actuator run time	60 ; 90 ; 120 ; 180 s
Proportional bands :	
For detector B1	± 0.5... 2(1) ...40 °C
For detector B2	± 0.5... 2(1) ...40 °C
For detector B2 (with B1 + B2)	± 1... 20(10) ...99 °C
Integral Time	- - -... 20(20) ...80 min.
On-Off differential	± 0.5... 2(1) ...40 °C
On-Off proportional cycle time	5 ; 10 ; 20 ; 30 min.

• Telemanagement

Speed C-Bus chosen from	1200, 2400, 4800, 9600 bps
-------------------------	----------------------------

In the presence of electrical disturbances the output controls of the controller may change status but this will return to normal automatically.

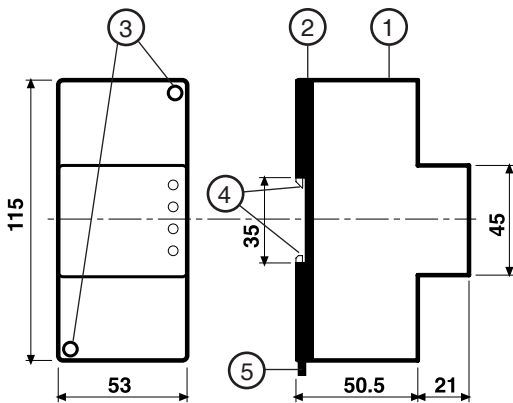
5. OVERALL DIMENSIONS

- 1 - Protective cover for electronic components
- 2 - Base with transformer, relay and terminal blocks
- 3 - Screws for securing base and cover
- 4 - DIN rail securing elements
- 5 - DIN rail release lever

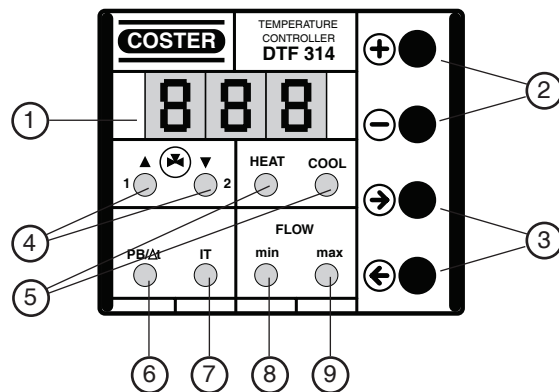
6. FRONT PANEL

- 1 - Three-figure numeric display
- 2 - + and - keys for adjusting parameters
- 3 - → and ← keys for viewing parameters
- 4 - Control output LEDs
- 5 - Heating/Cooling LED
- LEDs for data shown on display:
- 6 - Proportional Band or differential
- 7 - Integral Time
- 8 - Minimum limit range flow temperature
- 9 - Maximum limit range flow temperature

7. SITING

The controller must be installed in a dry location that meets the ambient limits given under TECHNICAL DATA. If installed in spaces classified as "Hazardous" it must be mounted in a cabinet for electrical appliances constructed according to the regulations in force for the type of danger concerned.

The controller can be installed on a DIN rail and in a DIN standard enclosure.

8. ELECTRICAL CONNECTIONS

Proceed as follows :

- Separate base from cover
- Mount base on DIN rail and check that it is firmly anchored by the securing elements (5.4)
- Carry out the wiring as in the diagram and in compliance with the applicable regulations in force and using :
 - 1.5 mm² cables for power supply and relay control outputs.
 - 1 mm² for detectors and remote control.
 - 1 mm² for C-Bus : For length limits see data sheet T 021.
- Apply power (24 V~) and check its presence across terminals 24 and 0.
- Remove power, replace cover on base/terminal block and secure it with the two screws supplied (5.3).

You are advised not to insert more than two wires in a single terminal of the controller and, if necessary, to use an external junction box.

9. WIRING DIAGRAMS

9.1 With 3-wire modulating output e.g. with run time of 120 seconds

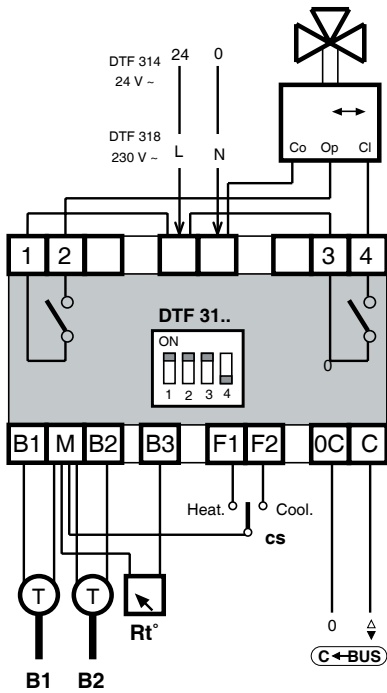

B1 – Temperature detector NTC 10 kΩ with range 0...40 °C
 B2 – Temperature detector NTC 10 kΩ with range 0...99 °C
 Rt° – Temperature adjuster
 cs – Remote season changer
 pos. 0 = control excluded with valve closing
 Or – Remote timer switch

9.2 With On-Off output in 2 stages

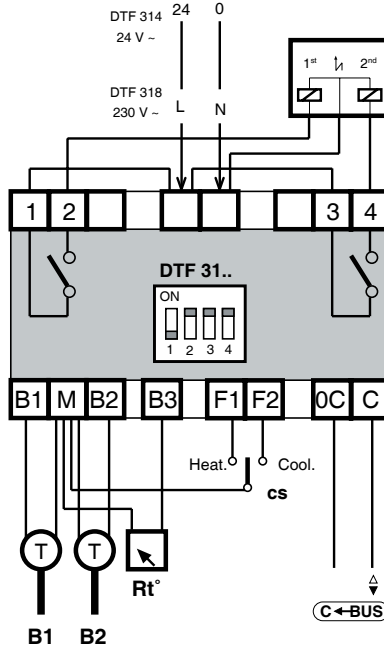

Y.1 – 3-wire modulating control
 Y.2 – Two-stage On-Off control
 Y.3 – On-Off control with proportional cycle
 C-Bus – Telemangement data transmission

9.3 With On-Off Proportional output e.g. with cycle time of 5 minutes

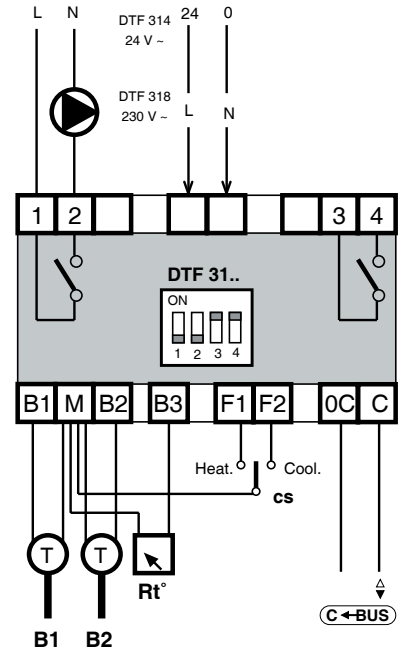

9.4 Remote control

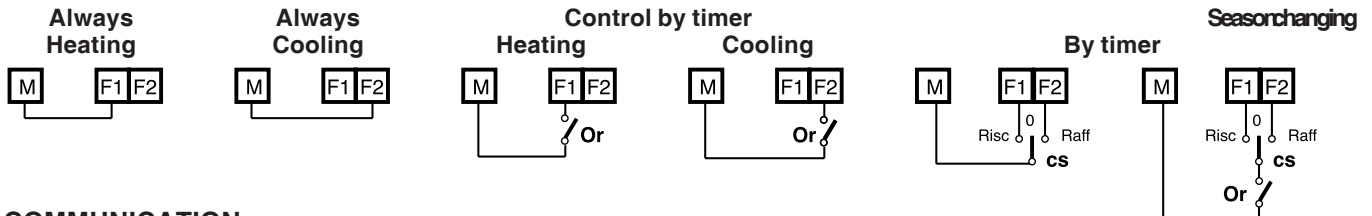

10. COMMUNICATION

10.1 C-Bus communication for Telemangement (for detailed information see data sheet T 021)

By means of the C-Bus output DTF 31.. can be Telemanged – two-way exchange of data with one or more local PCs and/or a central PCs via PSTN.
 From the PC or PCs you can see the values measured by the detectors and adjust the data set on the controller.

10.2 Electrical connection C-Bus

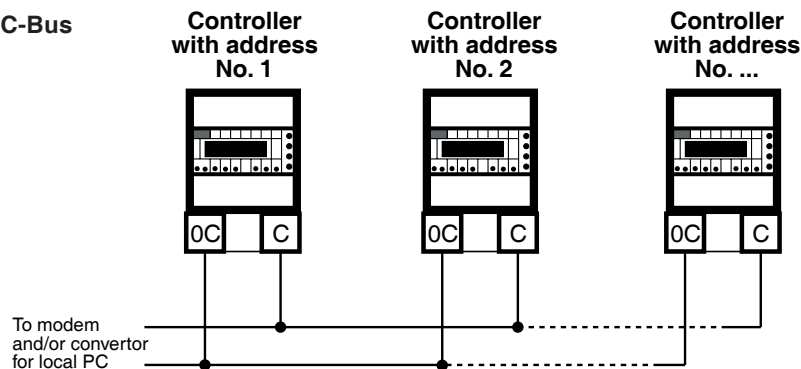

10.3 Address for Telemangement

In Telemangement, in order for the controllers to be identified by the central PC and /or by the local PCs, they have to be assigned a progressive address number:

- Press → key until all the LEDs are flashing.
- Display flashing: use + or – keys to enter address.
- Press → to return to first page

11. EXAMPLES OF INSTALLATION

11.1 Temperature control by modulating control of valve

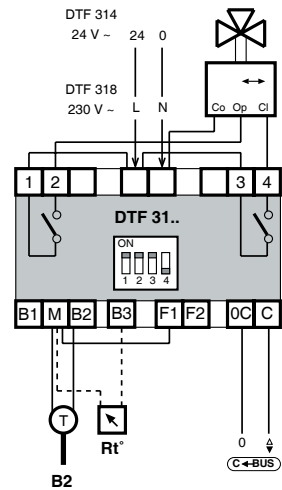
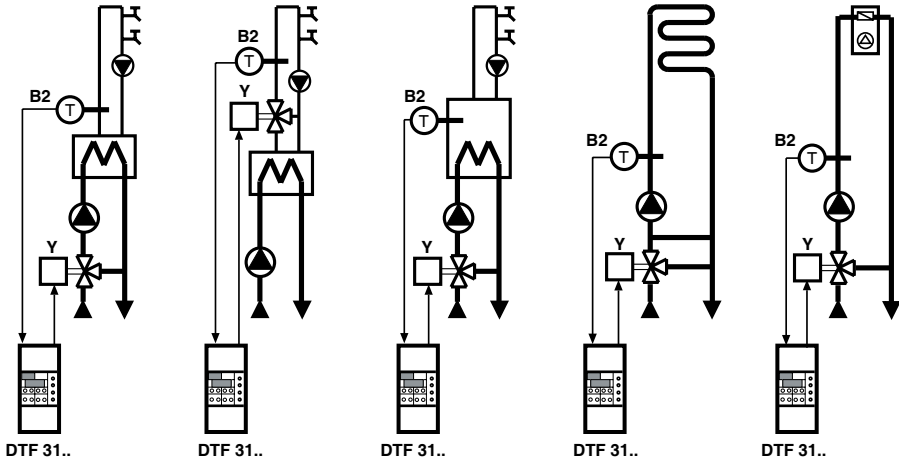

B2 – Water temperature detector (0...99 °C)
 Y – Control valve
 Rt° – Set-point adjuster (optional)

11.2 Temperature control by On-Off control of pump

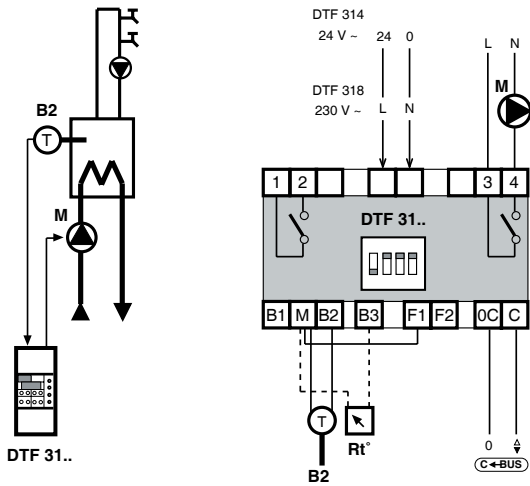

B2 – Water temperature detector (0...99 °C)
 M – Primary circuit pump
 Rt° – Set-point adjuster (optional)

11.3 Control of return temp. & flow water limits by On-Off control of pump

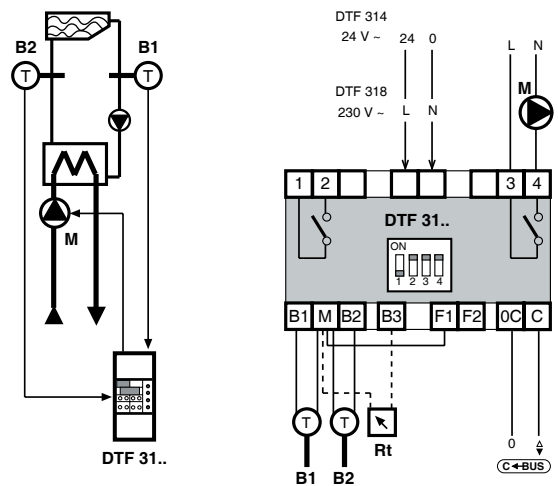

B1 – Swimming pool return water temp. detector (0...40 °C)
 B2 – Swimming pool flow water temp. detector (0...99 °C)
 M – Primary circuit pump
 Rt° – Set-point adjuster (optional)

11.4 Control temperature and limits flow water by modulating control of valve

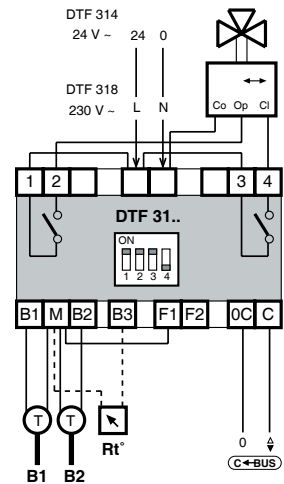
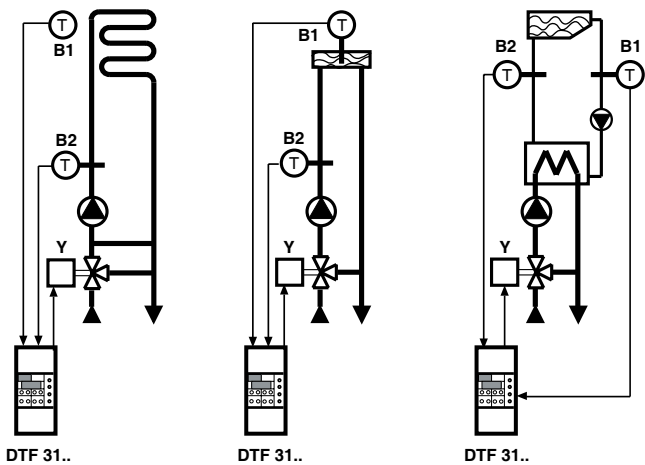

B1 – Primary temperature detector (0...40 °C)
 B2 – Flow water temperature detector (0...99 °C)
 Y – Control valve
 Rt° – Set-point adjuster (optional)

11.5 Control room temperature by On-Off Off control of heat generator in two stages

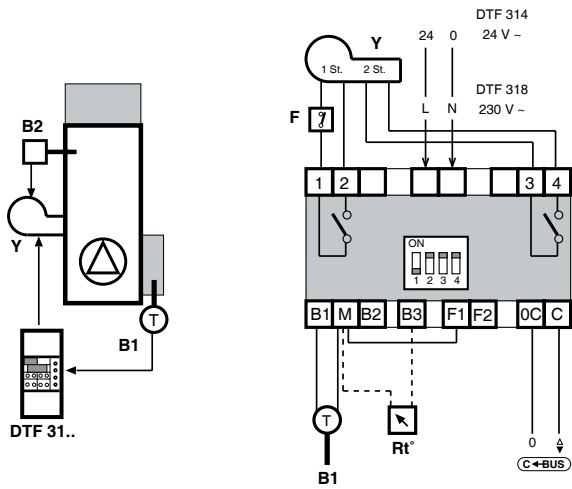

- B1 – Room temperature detector (0...40 °C)
- E – Two-stage burner
- F – Safety thermostat
- Rt° – Set-point adjuster (optional)

11.6 Control room temperature by On-Off proportional control of pump

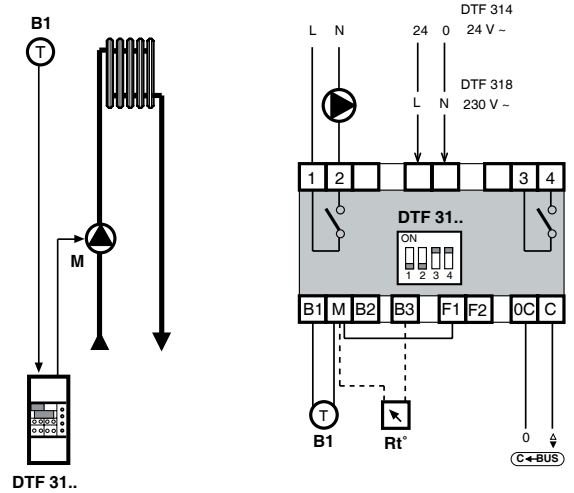

- B1 – Room temperature detector (0...40 °C)
- M – Plant pump
- Rt° – Set-point adjuster (optional)

10.7 Regolazione della temperatura minima di caldaia per l'inserzione in cascata

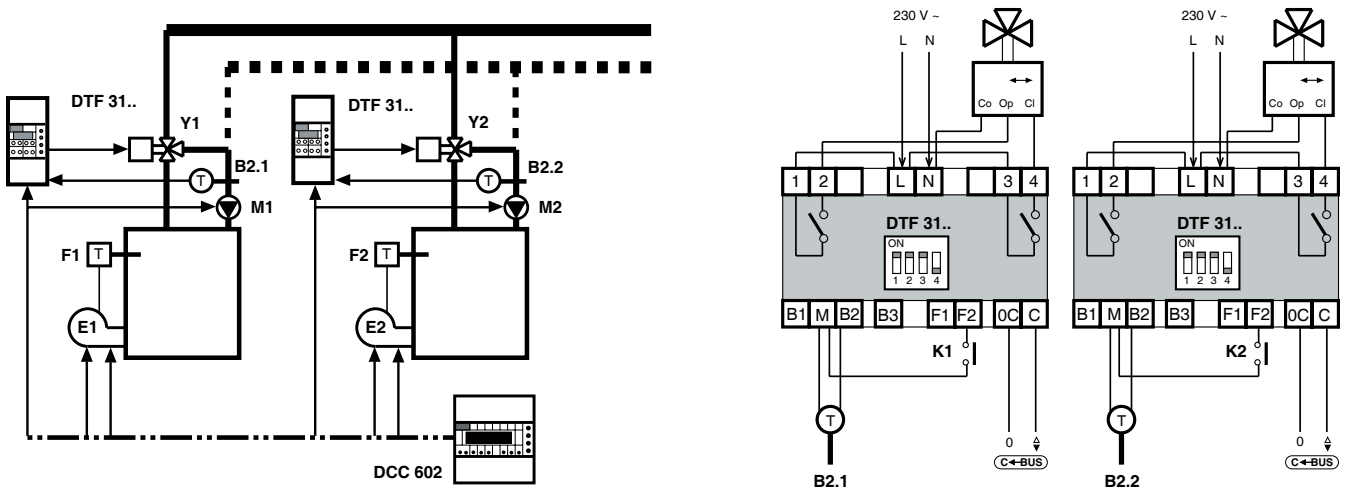

- B 2.1 – Boiler 1 temperature detector (0...99 °C)
- B 2.2 – Boiler 2 temperature detector (0...99 °C)
- Y1 – Boiler 1 valve
- Y2 – Boiler 2 valve
- K1 – Boiler 1 relay
- K2 – Boiler 2 relay
- M1 – Boiler 1 pump
- M2 – Boiler 2 pump

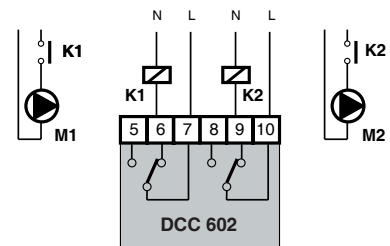

11.8 Control heating or cooling room temperature by modulating control of air supply damper units

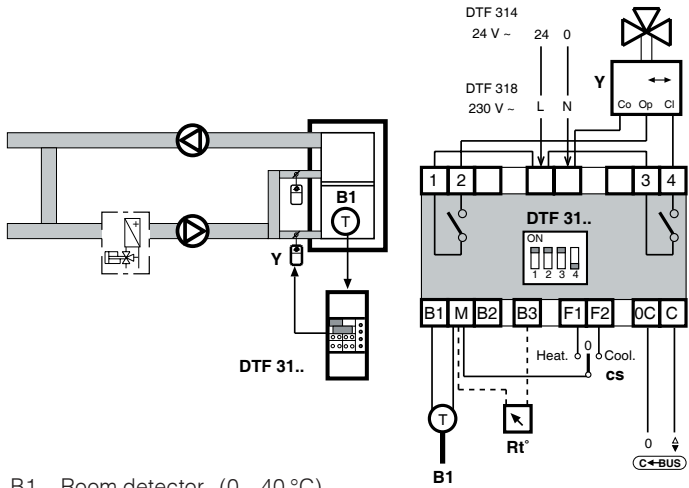

B1 – Room detector (0...40 °C)
 Y – Actuator terminal unit damper
 cs – Season switch
 Rt° – Set-point adjuster (optional)

11.9 Control mixed air temperature by modulating control mixing dampers

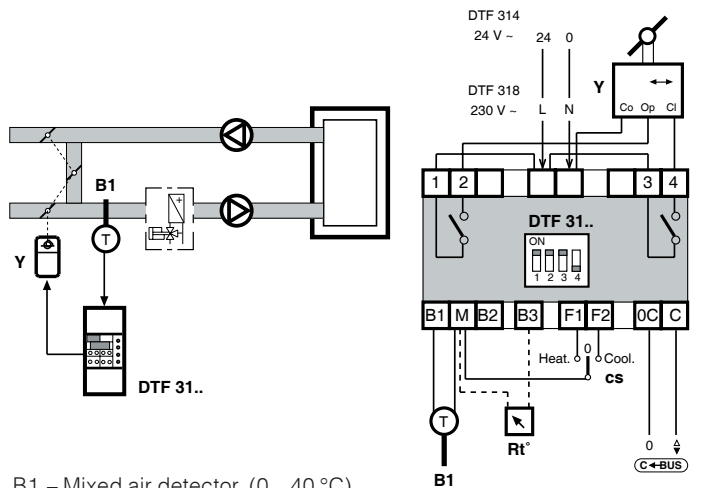

B1 – Mixed air detector (0...40 °C)
 Y – Actuator mixing dampers
 cs – Season switch
 Rt° – Set-point adjuster (optional)

11.10 Control heating or cooling room temperature or discharge air by modulating control signal

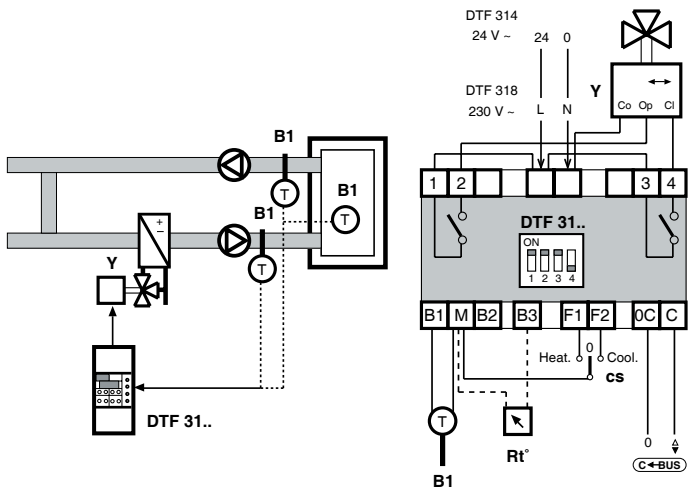

B1 – Discharge or extract air or room (0...40 °C) temp. detector
 Y – Control valve
 cs – Season switch
 Rt° – Set-point adjuster (optional)

11.11 Control heating room temperature or discharge air by On-Off in two stages

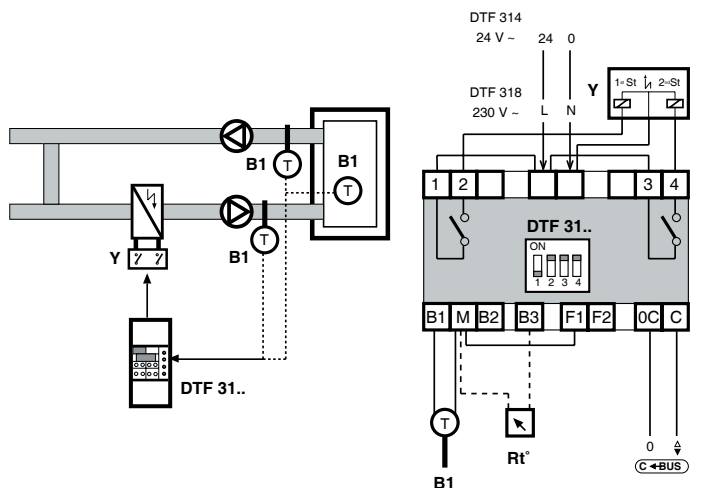

B1 – Discharge or extract air or room (0...40 °C) temp. detector
 Y – Electric battery
 Rt° – Set-point adjuster (optional)

11.12 Control temperature room cooling or discharge air by On-Off in two stages

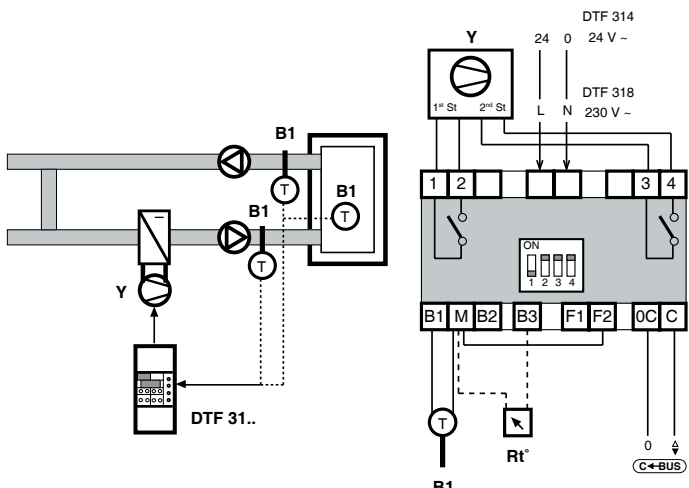

B1 – Discharge or extract air or room (0...40 °C) temp. detector
 Y – Refrigerator compressor
 Rt° – Set-point adjuster (optional)

11.13 Control pre-heating temperature and room heating or discharge air temperature by modulating control

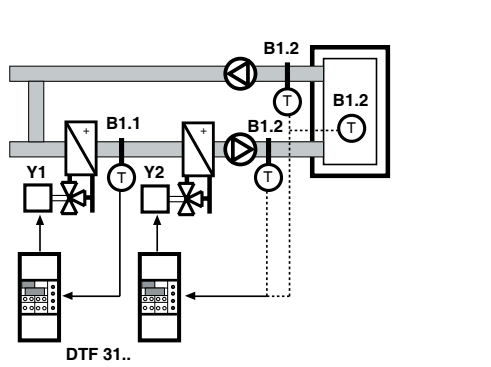

- B1.1 – Pre-heating temp. detector (0...40 °C)
- B1.2 – Discharge or extract air or room temp. detector (0...40 °C)
- Y1 – Pre-heating control valve
- Y2 – Post-heating control valve
- Rt° – Set-point adjuster (optional)

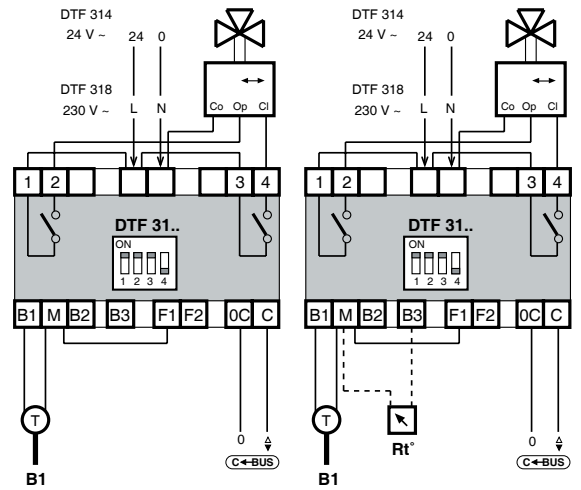

11.14 Control pre-heating temperature and room heating and discharge air limits temperature by modulating control

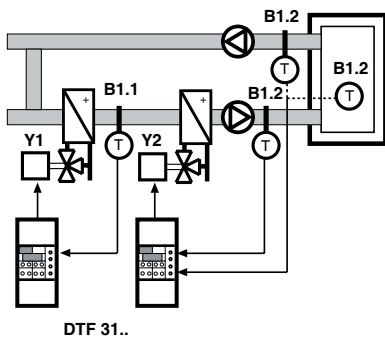

- B1.1 – Pre-heating temp. detector (0...40 °C)
- B1.2 – Room or extract air temp. detector (0...40 °C)
- B2 – Discharge air temp. detector (0...99 °C)
- Y1 – Pre-heating control valve
- Y2 – Post-heating control valve
- Rt° – Set-point adjuster (optional)

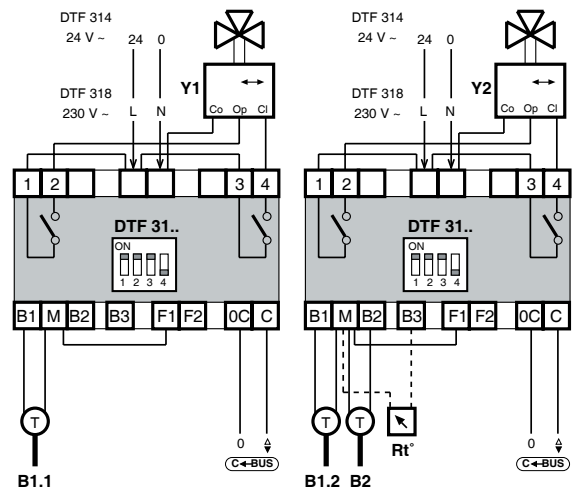

11.15 Control of winter pre-heating temperature in an air handling plant

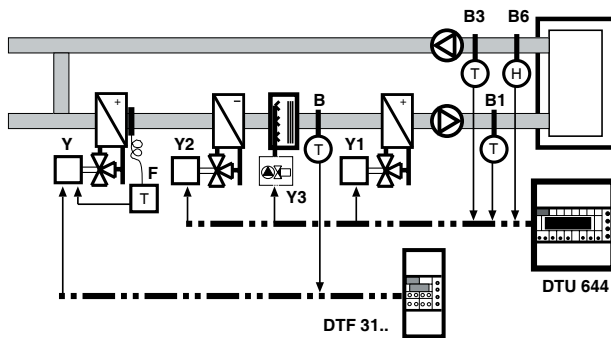

- B – Pre-heating temp. detector (0...40 °C)
- B1 – Discharge air temp. detector
- B3 – Room or extract air temp. detector
- B6 – Humidity detector
- F – Frost protection thermostat
- Y – Pre-heating control valve
- Y1 – Post-heating control valve
- Y2 – Cooling control valve
- Y3 – Humidification unit
- cs – Season switch

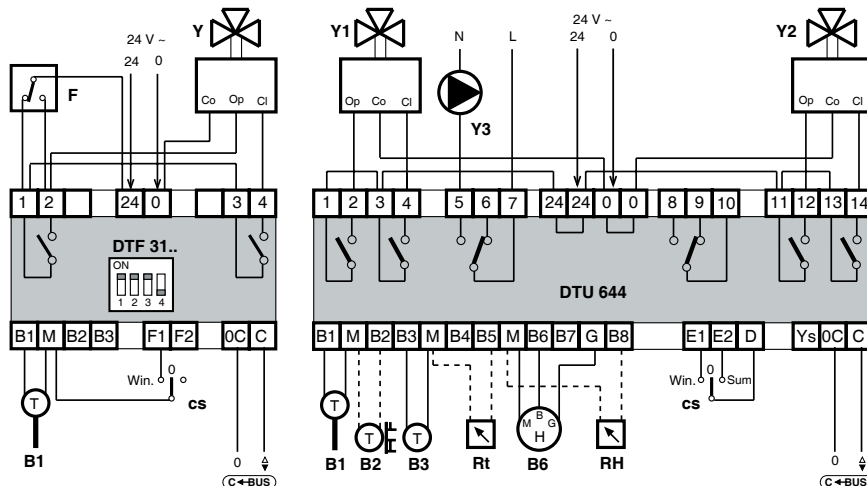

12. OPERATION

DTF 31.. is a microprocessor-based digital controller for the control of temperature measured by:

- Detector B1 only (NTC 10 kΩ, range 0...40 °C) : room temp., chilled water temp., etc.
or
- Detector B2 only (NTC 10 kΩ, range 0...99 °C) : hot water temp., flow temp., etc.
or
- Room or primary temp. detector B1 and flow temp. detector B2.

with action : Heating if : M F1 F2 or Cooling if : M F1 F2

with control output:

- Three-wire modulating
- On-Off in one or two stages
- On-Off proportional in one stage

12.1 Configuration



The controller must be configured according to its use, by means of the dipswitches located on the base. Bold type indicates the position of the dipswitches cursor (actually white).

The factory pre-set configuration is **three-wire modulating control** with **run time of 60 seconds**.

To change the type of control, position only the dipswitches concerned as indicated in the table.

Dipswitch	Function	Description	Dipswitch position
1	Type of control output	Three-wire modulating control On-Off control	On Off
2	Control type On-Off (only if 1 is Off)	On-Off in 1 or 2 stages On-Off proportional	On Off
3 - 4	Valve run time (only if 1 is On)	60 seconds 90 seconds 120 seconds 180 seconds	3 and 4 On 3 and 4 Off 3 On and 4 Off 3 Off and 4 On
3 - 4	Half-load cycle time (only if 1 and 2 are Off)	5 minutes 10 minutes 20 minutes 30 minutes	3 and 4 On 3 and 4 Off 3 On and 4 Off 3 Off and 4 On

12.2 Control with one detector (B1 or B2)

The controller compares the desired temperature T^+ (Heating) or T^- (Cooling) with the temperature t^* measured by detector B1 or B2 and calculates the value of control output Y in relation to the difference and the parameters set.

- **Three-wire modulating output with PI mode**
1-2 : valve opening
3-4 : valve closing

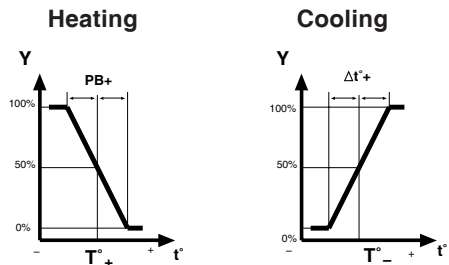

- **On-Off output in one or two stages with PI mode for P mode (pure differential)**
set Integral Time = - - - -
1-2 : 1st stage
3-4 : 2nd stage

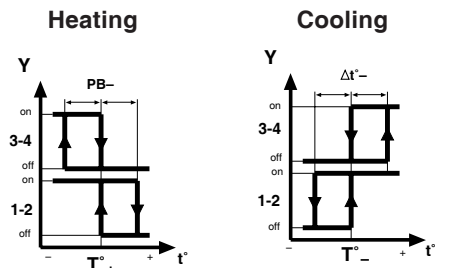

- On-Off output with Proportional cycle
1-2 : control

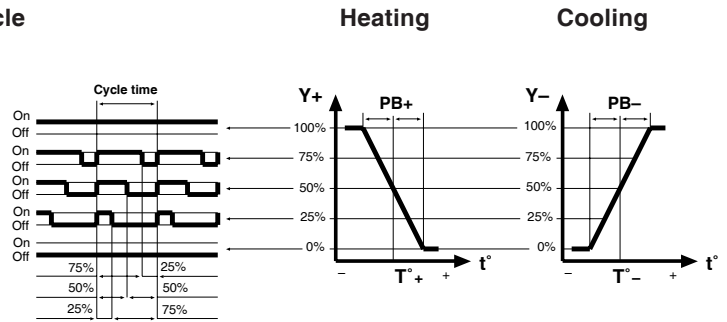

12.3 Control with two detectors (B1 and B2)

The controller compares the desired temperature $T^{\circ}+$ (Heating) or $T^{\circ}-$ (Cooling) with the temperature t° measured by detector B1 and calculates the desired flow temperature $T^{\circ}f+$ (Heating) or $T^{\circ}f-$ (Cooling) in relation to the difference and the variation range of the flow temperature.

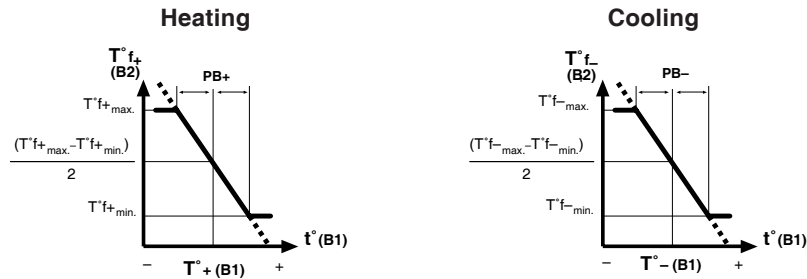

The controller compares the desired flow temperature $T^{\circ}f+$ (Heating) or $T^{\circ}f-$ (Cooling) with the flow temperature $t^{\circ}f$ measured by detector B2 and calculates the output value of control Y in relation to the difference and the parameters set.

- Three-wire modulating output with PI mode
1-2 : valve opening
3-4 : valve closing

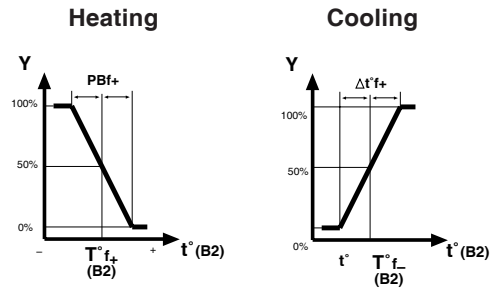

- On-Off output in one or two stages with PI mode for P mode (pure differential)
set Integral Time = - - - . -
1-2 : 1st stage
3-4 : 2nd stage

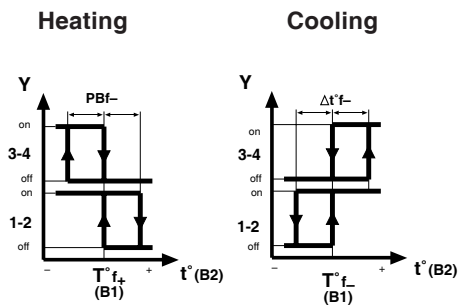

- On-Off output with Proportional cycle
1-2 : control

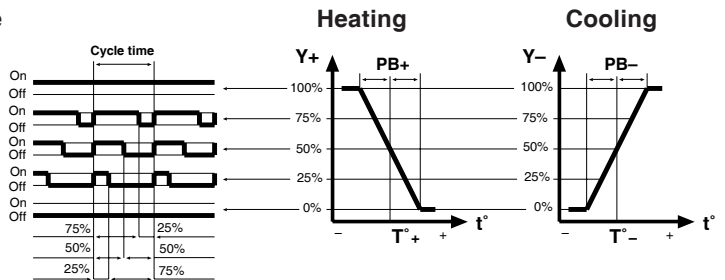



13. SETTING PARAMETERS



The setting parameters must be set after having completed the electrical wiring and carried out the configuration of the microswitches (section 12.1).

The display normally shows the temperature measured by the detector:

- B1 : if only B1 connected or if B1 and B2 connected.
- B2 : if only B2 connected.



When there is a short or open circuit to the detector, or the value measured is outside limits, a dash appears on the display.

The keys  and  permit viewing the setting parameters (display flashing).

The  and  keys permit adjusting the parameters shown on the display.

The type of parameter shown on the display is indicated by the lighting up or flashing of the relative LED.

If for 60 seconds no key is pressed the display returns to show the measured temperature.

To return to the default (factory) values remove power from the controller and re-power it while keeping pressed the  and  keys until on the display appears InI and the measured temperature; release the keys.



13.1 Control with detector B1 only or B2 only



The parameters for Heating and Cooling are separate:



With   LED "HEAT" lit. Enter data for Heating.



With   LED "COOL" lit. Enter data for Cooling.



Display fixed with temperature measured by B1 or B2.

Press  : Display flashing with desired temperature T°.
Adjust with  or  (resolution 0.5 °C).
If remote control Rt connected and a variation greater than ± 0.5 is set, the value T° includes the connection value of remote control and LEDs "HEAT" and "COOL" flash.

Keep  pressed until on display appears ---, release the key:
Display flashing with Proportional Band PB
LED "PB/Δt" lit.
Adjust with  or  (resolution 0.5 °C).

Press  : Display flashing with Integral Time IT only if Modulating or On-Off in 1 or 2 stages.
LED "IT" lit.
Adjust with  or  (resolution 1 minute).

Premere  : Display flashing with C-Bus speed **b 12** (default 1200 bps)
Led "ti", "Min", "Max" lit.
Adjust with  or  to set the desired speed
(**b 24** = 2400 bps; **b 48** = 4800 bps e **b 96** = 9600 bps)

Press  : Display flashing with Telemangement address
All LEDs flashing
To adjust use  or 

Press  : Display fixed with temperature measured by B1 or B2; however if for 60 seconds no key is pressed the display returns to show the measured temperature.





























13.2 Control with detector B1 and detector B2

The parameters for **Heating** and **Cooling** are separate:

With   "HEAT" LED lit. Enter data for Heating.

With   "COOL" LED lit. Enter data for Cooling.

Display fixed with temperature measured by B1.

- Press  : Display flashing with desired temperature T° (B1).
Adjust with  or  (resolution 0.5 °C).
If remote control Rt connected and a variation greater than ± 0.5 °C is set, the value T° includes the correction value of the remote control and LEDs "HEAT" and "COOL" flash.
- Press  : Display fixed with flow temperature measured by B2.
FLOW min and max" LED flashing.
- Keep pressed  until on display appears ---, release the key:
Display flashing with Proportional Band PB for detector B2
LED "PB/ Δt " lit.
Adjust with  or  (resolution 0.5 °C).
- Press  : Display flashing with Integral Time IT for detector B1, only if Modulating or On-Off in 1 or 2 stages.
LED "IT" lit.
Adjust with  or  (resolution 1 minute).
- Press  : Display flashing with minimum flow temperature T°_{min} which defines the minimum limit of variation range of flow temperature B2.
LED "max FLOW" lit.
Adjust with  or  (resolution 0.5 °C).
- Press  : Display flashing with maximum flow temperature T°_{max} which defines the maximum limit of variation range of flow temperature B2.
LED "FLOW max" flashing.
Adjust with  or  (resolution 0.5 °C).
- Press  : Display flashing with Proportional Band PB for detector B2,
LED "PB/ Δt " lit.
LED "FLOW min and max" flashing.
Adjust with  or  (resolution 0.5 °C).
- Press  : Display flashing with Integral Time IT for detector B2, only if Modulating or On-Off in one or two stages
LED "IT" lit.
LED "FLOW min and max" flashing.
Adjust with  or  (resolution 1 minute).
- Press  : Display flashing with C-Bus speed **b 12** (default 1200 bps)
Led "ti", "Min", "Max" lit.
Adjust with  or  to set the desired speed
(**b 24** = 2400 bps; **b 48** = 4800 bps e **b 96** = 9600 bps)
- Press  : Display flashing with Telemangement address
All LEDs flashing
To adjust use  or 
- Press  : Display fixed with temperature measured by B1; however if for 60 seconds no key is pressed the display returns to show the measured temperature.

Amendment to data sheet

Date	Revision No.	Page	Section	Amendment description	Firmware	Software
15.07.08 AM	01	8, 10, 11	various	Update wiring diagram for cooling parameter	08	≥ 0.86.1647
02.12.09 VM	02	2, 10, 11	various	Added C-Bus speed display	-	> 0.99.2650



COSTER TECNOLOGIE ELETTRONICHE S.p.A.
Sede Legale: 20132 Milano - Via San G.B. De La Salle, 4/a

Head Office & Sales

Via San G.B. De La Salle, 4/a Tel. +39 022722121
20132 - Milano Fax +39 022593645
Orders Fax +39 0227221239

Reg. Off. Central & Southern

Via S. Longanesi, 14 Tel. +39 065573330
00146 - Roma Fax +39 065566517

Shipping

Via Gen. Treboldi, 190/192 Tel. +39 0364773200
25048 - Edolo (BS) Tel. +39 0364773202

E-mail: info@coster.info Web: www.coster.eu



D 33204